

VENTILATION SOLUTIONS FOR EXISTING DWELLINGS

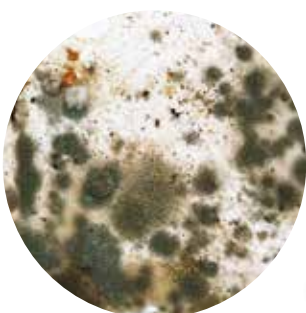

A ventilation manufacturer with unrivalled choice and service

► Nuaire is the UK leader in the design and manufacture of fans and ventilation systems. We put our energy into efficient ventilation so you don't waste yours.

Based in South Wales, our factory covers over 25,000m³, allowing us to manufacture a wide variety of ventilation products from raw materials to finished goods.

We source almost all of our components from the UK, keeping both our carbon footprint to a minimum and ensuring industry-leading delivery times to customers.

Since our inception in 1966, Nuaire have pioneered a number of ventilation strategies and products widely adopted by the industry, from the twin fan to the Opus residential fans through to the invention of Positive Input Ventilation.



MADE IN GREAT BRITAIN

The latest technology for PIV; low watt heaters and wireless controls

Market leader in PIV since invention; our PIV history

► Nuaire invented Positive Input Ventilation (PIV) in 1972



Continually evolving our extract fans since 1966

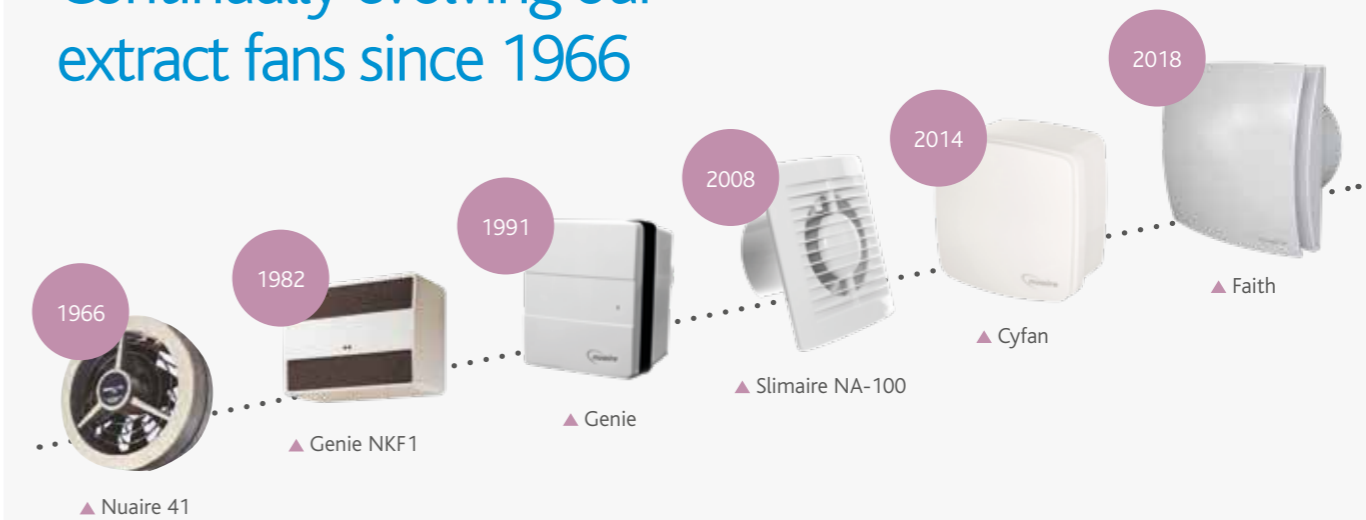

A fast growing problem

- ▶ External and internal pollutants can have a significant impact on the quality of air in every home and consequently on occupants' health.

Poor ventilation is a wide-scale problem. It is estimated that one in five UK households are poorly ventilated, leading to problems with streaming windows, mould growth and poor indoor air quality.

Condensation dampness is the major indoor air pollutant caused by modern living. Energy-efficiency measures such as cavity wall insulation and double-glazing make homes warmer by sealing in the heat. But as a result, the humid, stale air becomes trapped inside the home leading to condensation and the appearance of black mould.

Through everyday life (cooking, cleaning, breathing) the average family produces over 17 pints of moisture a day. Condensation forms when this moisture comes into contact with cold surfaces within the home. This condensation will lead to mould growth, which is not only unpleasant but is damaging to the fabric of the building and creates unnecessary costs for the registered landlord in decoration and maintenance.

Effects on health

Poor indoor air quality has significant impact on the health and wellbeing of occupants. Studies have firmly linked poor indoor air

quality with a range of undesirable illnesses, such as allergic and asthma symptoms, airborne respiratory infections, and even lung cancer and stroke.

The importance of good ventilation

Ventilation is critical to home comfort and improved health. Adequate ventilation improves air quality and rids the home of air pollutants. It controls the moisture levels in the home, preventing condensation dampness and black mould from forming.

These factors combine to enhance the comfort and indoor air quality of the home and ensure a healthy environment. Effective ventilation also contributes to preserving the structural integrity of the home, reducing maintenance costs and adding to the home's value.

On average, occupants spend over 80% of their time indoors so indoor air quality matters.

ACTIVITY	PINTS OF MOISTURE	
Cooking with Gas		5.2
Clothes Washing and Drying		5.1
Showering		1.6
Breathing (4 people)		5.6
DAILY TOTAL		17.5

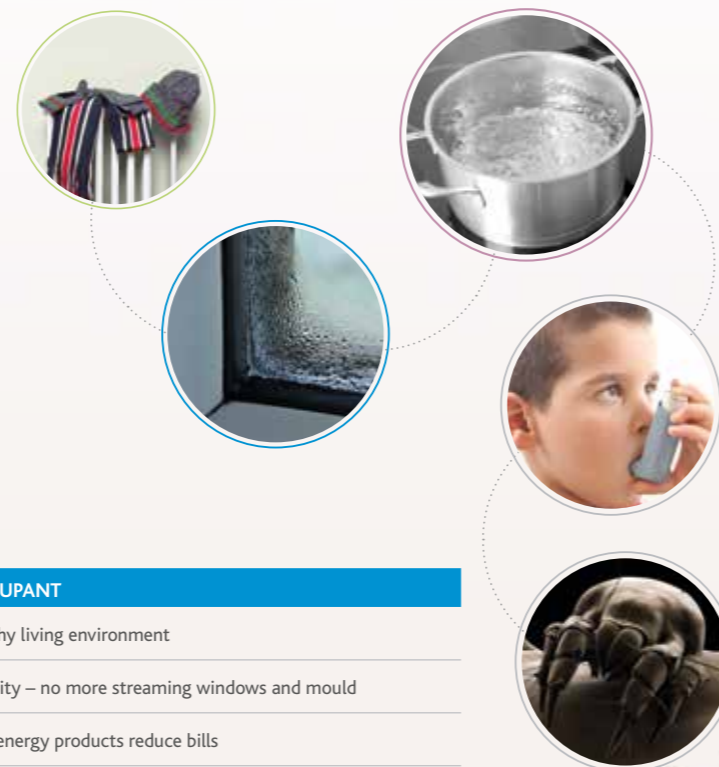

Benefits to providing adequate ventilation

FOR THE LANDLORD	FOR THE OCCUPANT
Compliance to ADF and ADL Building regulations	Creates a healthy living environment
Easy Installations	Controls humidity – no more streaming windows and mould
Low life-cycle costs	Extremely low energy products reduce bills
Preserves the building fabric (reducing maintenance costs)	Low noise levels
Maintains long tenancies	Minimal maintenance
Improves tenant wellbeing and health, avoiding legal claims	Addresses harmful indoor air pollutants such as VOCs and Radon gas

How can Nuaire help you?

- ▶ As the **UK's leading ventilation provider** we understand your requirements and have staff on hand to help.

Our offices in South Wales manage schedules, orders and can help on technical enquiries. With over 65 external sales staff we are always on hand to help with product information, training or best practice advice.

Full ventilation training

If you have a DLO, or subcontract your ventilation installers, Nuaire offers free ventilation training that is BPEC and NICEIC accredited. As active members of numerous industry bodies, Nuaire promotes best ventilation installation practice. As fabric improvements and insulation schemes have been commonplace for many years, it's important to review ventilation when refurbishment occurs.

A comprehensive range of products

Nuaire offers a wide range of ventilation products. For renovation of existing buildings, we offer a wide range of axial and centrifugal fans. We also offer 'twin fans' solutions for central ventilation on tower blocks. For planned maintenance on newer homes, we also offer our MEV/MVHR range of fans and spares.



Contact your local rep for free

seminars on condensation and mould

- ▶ Condensation workshops
- ▶ Toolbox talk on regulations
- ▶ Upkeep and maintenance for MEV and MVHR
- ▶ Custom CPD's on request



VENTILATE THE HOME WITH POSITIVE INPUT VENTILATION (PIV)

► Installed in over 1 million homes in the UK, Positive Input Ventilation (PIV) systems provide a continuous supply of fresh, filtered air into the home through positive pressurisation, creating an environment in which condensation and mould growth cannot exist.

Nuaire invented PIV over 40 years ago

Poor ventilation within Local Authority, Housing Association and tenanted properties is a large and growing problem. Badly ventilated properties lead to problems such as streaming windows, mould growth and poor indoor air quality.

Without adequate ventilation the moisture produced by washing, cooking and bathing remains trapped inside.

▼ PIV How does it work?

Moisture and condensation are driven out

The filtered air gently pressurises the home from inside out, forcing out the stale air.



Create a healthy living environment

Improves indoor air quality removing pollutants such as VOCs, keeps out external pollutants such as traffic fumes and pollen.

No need to open windows to ventilate

Clean, fresh air is continuously drawn through the lofts' natural leakage points, passed through the filters and fed into the property via a central hallway diffuser.

Choosing the right PIV unit

	DRI-ECO- LC	DRI-ECO- HC	DRI-ECO- LINK-HC	DRI-ECO- HEAT-HCS	DRI-ECO- HEAT-HC	DRI-ECO-3STOREY	DRI-ECO3S-HEAT-HC	DRI-365	FLATMASTER	FLAT2000L/R
With lofts	✓	✓	✓	✓	✓	✓	✓	✓		
Without lofts									✓	✓
Single storey	✓	✓	✓	✓	✓			✓	✓	✓
Two storey	✓	✓	✓	✓	✓			✓		
3 storey						✓	✓			
Works with RH sensor			✓		✓		✓			
Works with CO2 sensor			✓		✓		✓			
Works with 2-way boost switch			✓							
Works with 4-way boost switch					✓		✓			
Setting and control behind diffuser		✓	✓	✓	✓		✓			
Setting and control on unit	✓					✓		✓	✓	✓
5 year warranty*	✓					✓		✓	✓	✓
7 year warranty*		✓	✓	✓	✓		✓			

*1 year parts and labour, remaining years parts only

POSITIVE INPUT VENTILATION (PIV)

PIV for 2 storey or single storey loft dwellings

▶ The Drimaster-Eco range uses the Positive Input Ventilation principle to provide the home with whole-house ventilation. It involves introducing fresh filtered air into the dwelling at a continuous rate, encouraging movement of air from the inside to outside. This unit is suitable for 2 storey and single storey properties with loft space.



Features and benefits for Positive Input Ventilation

- ▶ Continuously reduces moisture levels within the home
- ▶ Meets Building Regulations
- ▶ Extremely low power consumption
- ▶ Extremely quiet operation
- ▶ Designed to create an easy and non-disruptive installation
- ▶ Daily run monitor as standard
- ▶ 7 segment display for visual enhanced controllability
- ▶ Very low maintenance requirement
- ▶ Can be installed to help reduce Radon gas levels
- ▶ Significantly improves the indoor air quality in the home
- ▶ Proven to improve tenants' health by reducing allergens within the home
- ▶ Protects the fabric of the home by alleviating condensation dampness
- ▶ Automatic heat recovery mode
- ▶ Up to 7 years' warranty*



DRI-ECO-HC

Providing ease of commissioning and install for housing providers when carrying out maintenance checks, this PIV unit has system controls located behind the diffuser.



DRI-ECO-LC

This PIV unit offers the latest energy-saving technology which can reduce energy bills and power consumption in the home. The controls are sited in the loft on the unit.



DRI-365

Suitable for properties with a loft space, this unit ensures and protects indoor air quality all year round. This energy saving unit introduces fresh cooler filtered air into the home throughout the warmer months, whilst intelligently utilising solar gain from loft space during the colder, ensuring a comfortable living environment throughout the year.

Please note you are required to choose one of the below codes for the additional kit needed to complete the install:

- ▶ DRI365-SOFITKIT
- ▶ DRI365-WALKIT



DRI-ECO-HEAT-HC

An integral 400W heating element to temper the airflow on entering the property. Suitable for all properties with a loft space, this unique PIV system has controls situated behind the diffuser for ease of commissioning and maintenance checks. The development of new technology also provides additional benefits for both the housing provider and the occupant, relative humidity (RH) and carbon dioxide sensors which will automatically increase the fans speed when the target setting on the sensors are met. This maintains good indoor air quality.



DRI-ECO-HEAT-HCS

Suitable for all properties with a loft space, this PIV system is a variant of the Dri-Eco-Heat-HC. Integral 400W heating element tempers the airflow on entering the property and this variant is for applications where additional controls and RF compatibility is not required.



DRI-ECO-LINK-HC

This unit is a standard unit with the added benefit of being compatible with a relative humidity sensor and CO₂ sensor. With suitability for loft installation, this unit also has discrete commissioning and controls behind the diffuser.

Kits available



▶ DRI365-SOFITKIT



▶ DRI365-WALKIT

Sensors available



▶ DRI-ECO-2S
2-way switch



▶ DRI-ECO-RM
Remote monitor



▶ DRI-ECO-CO2
Carbon dioxide sensor



▶ DRI-ECO-4S
4-way switch



▶ DRI-ECO-RH
Relative humidity sensor

* 1 year parts and labour, remaining years parts only

POSITIVE INPUT VENTILATION (PIV)

3 storey loft PIV

► Using the same Positive Input Ventilation technology, the following products are suitable for install within 3 storey properties with a loft space. By using an intumescent aluminium diffuser in order to meet fire regulation standards, this range offers whole-house ventilation with improved indoor air quality.



► **DRI-ECO3S-HEAT-HC**
This low energy-unit has a 400W heating element to temper airflow when upon entering the property. This unit has hall controls situated behind the diffuser providing ease of commissioning and maintenance checks and is suitable for installation in 3 storey properties. This unit is compatible with sensors as per standard the DRI-ECO-HEAT-HC unit.



► **DRI-ECO-3STOREY**
Suitable for 3 storey property application, this unit is a cost-effective solution to enhancing indoor air quality within homes. Controls are situated on the unit with the loft.

Install application

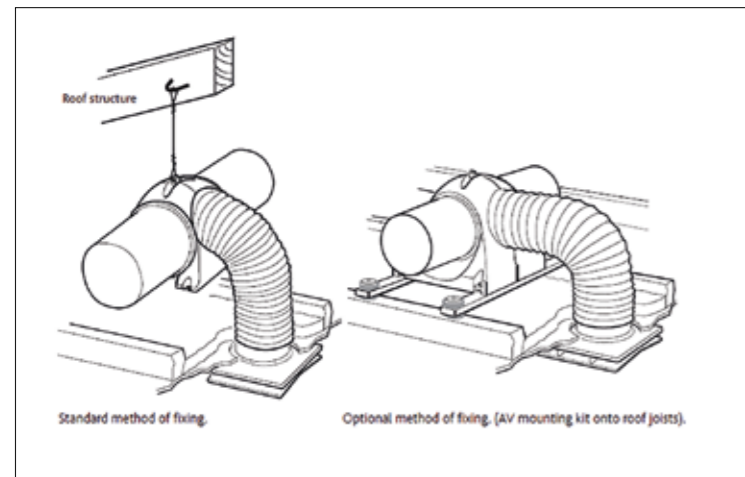

We offer a range of ducting and ancillaries, see page 19

Properties without loft space

► Ideal for properties without loft space, this low cost ventilation unit is designed to take fresh air from outside using the same Positive Input Ventilation Technology.



► **FLAT2000L**
Built with an integral heater, this unit tempers the air brought in from outside the property helping to cure condensation dampness and remove allergens and pollutants from the home. This unit is a left hand discharge.



► **FLAT2000R**
Built with an integral heater, this unit tempers the air brought in from outside the property helping to cure condensation dampness and remove allergens and pollutants from the home. This unit is a right hand discharge.



► **FLATMASTER**
Situated in a convenient location within the home and ducted to a central location, this low-energy unit introduces air into the home at a continuous low rate ensuring allergens are kept to a minimum improving indoor air quality.

Install application

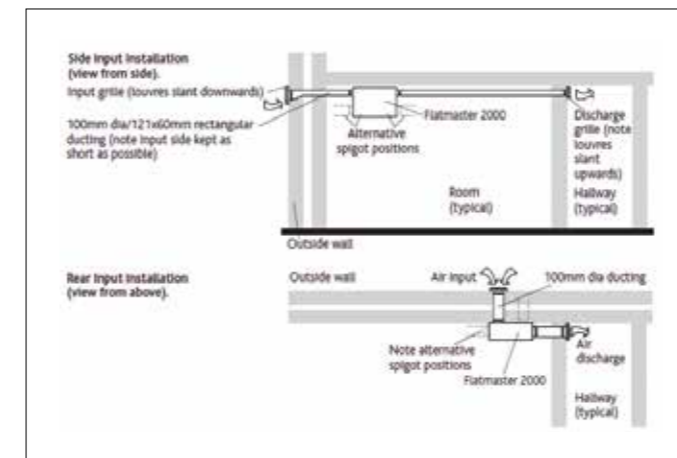

Switch available



▲ FAN CONTROLLER

TWIN FAN OPTIONS FOR TOWER AND MULTI OCCUPANCY BUILDINGS

PROVIDING VENTILATION 24/7

Repair and replacement for tower blocks



▲ Airevolve

► Nuair offer a wide range of commercial ventilation solutions, some of which are suitable for existing residential dwellings. In many inner city locations, high rise buildings are ventilated with 'Twin Fans' where a central system is positioned on a roof.

Airevolve twin fan (up to 0.18 m³/s)



▲ AVT Internal In-line Twin Fans



▲ AVT-R External In-line Twin Fans with grille outlet

▼ Side discharge grille

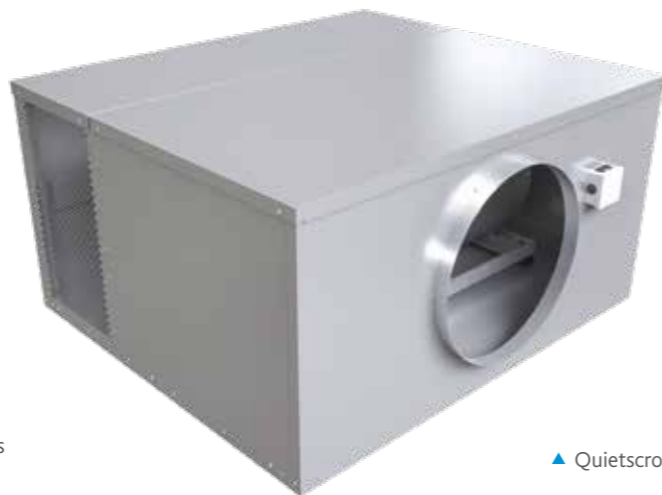

▲ Quietscroll

Quietscroll twin fan (up to 4.5 m³/s)

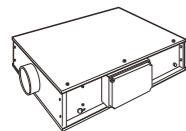

▲ EST Internal in-line twin fans

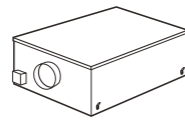

▲ EST-X External in-line twin fans

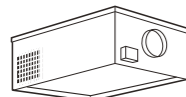

▲ EST-R Roof mounted twin fans with end inlet and side discharge



▲ EST-B Roof mounted twin fans with bottom inlet and side discharge



FAN ANCILLARIES

FLATMASTER ANCILLARIES

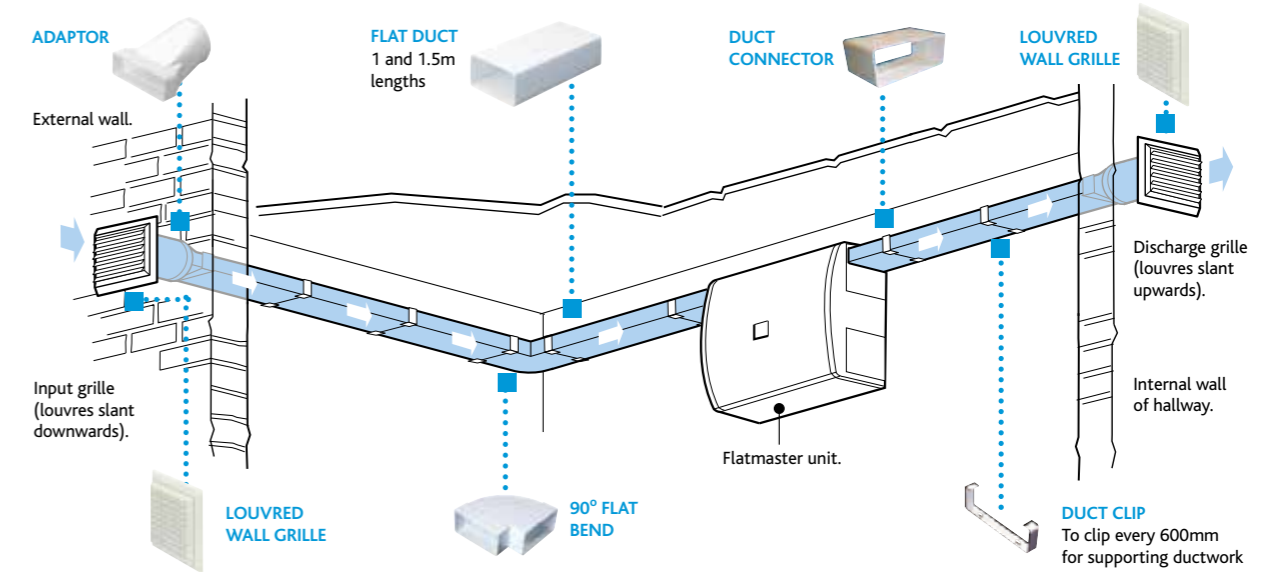

Adaptor

PVC470WH – Rectangular to round duct 121 x 60mm/100mm dia.

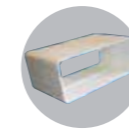

Duct Connector

PVC420WH – 121 x 60mm



Louvred Wall Grille

PVC104LR – 100mm dia. spigot Low resistance



Flat Duct

• PVC4015WH – 121 x 60mm 1m and 1.5m lengths
• PVC4010WH – 1m lengths



90° Flat Bend

PVC450WH – 121 x 60mm



Duct Clip

PVC422WH – 121 x 60mm



90° Vertical Bend

PVC460WH – 121 x 60mm

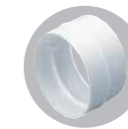

Duct Connector

PVC493WH – 100mm dia.

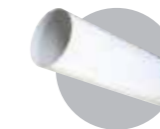

Round Duct Pipe

• PVC1200-4WH – 100mm dia. 2m length
• PVC1100-4WH – 1m lengths



90° Bend

PVC490WH – 100mm dia.



Duct Clip

PVC496WH – Pipe hanger 100mm dia.



Round Wall Grille

PVC104-CNFS – 100mm dia. spigo

DUCTING ANCILLARIES AND FIRE PRODUCTS



Duct Accessories

- PVCSEAL – Ducting sealant
- PVC50TP45 – Aluminium Duct Tape 45m
- PVCSEAL – Intumescent Duct Sealant



Circular Fire Damper

- CFD-100-E60S – 100mm
- CFD-125-E60S – 125mm
- CFD-160-E60S – 160mm



Circular Fire Damper Air Valve

- V-FD100-E60S – 100mm
- V-FD125-E60S – 125mm, Wall mount only
- V-FD125-125 – 125mm, Ceiling mount only

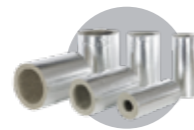

Fire Wrap

- FW110X54T – 110 x 54mm Firemm Damper
- FW204X60T – 204 x 60mm Fire Damper
- FW220X90T – 220 x 90mm Fire Damper
- PVC488T – 100mm Fire Damper
- PVC588T – 125mm Fire Damper
- PVC688T – 150mm Fire Damper

SPARE FILTERS FOR DRI-ECO, FLATMASTER, MEV & MVHR

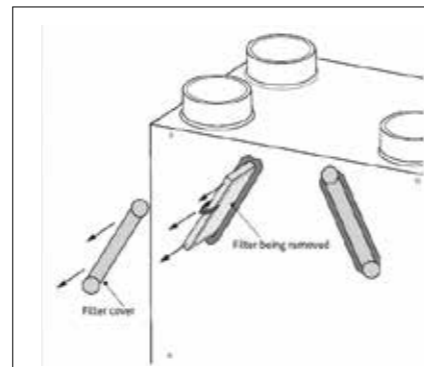
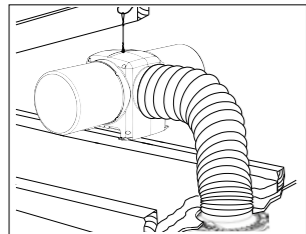

FLAT-FILTERKIT



DRIPOS2001-FILTERKIT / DRI-ECO FILTERKIT



MEV-G2-FILTERKIT



MVHR-WM2-FILTERKIT / MVHR-WH1-FILTERKIT / MVHR-WH2-FILTERKIT / MVHR-ECO2-FILTERKIT



MVHR-WH1-FILTERKIT / MVHR-ECO3-FILTERKIT



MVHR-WH1-FILTERKIT / MVHR-ECO4-FILTERKIT

INDOOR AIR QUALITY (IAQ)

AND OUR P.I.V SOLUTION

Indoor Air Quality (IAQ) is the quality of the air you breathe in your home. **How clean is the air within your home?**

Poor indoor air quality, or indoor air pollution, occurs when there is a build up of pollutants in the home to the extent that it affects an occupant's health and comfort.

WHAT YOU CAN DO NOW

- ✓ IAQ can be managed and kept at a healthy level by reducing the number of pollutants in the home
- ✓ Ensure your home is properly ventilated; ventilation is installed, well maintained and switched on
- ✓ Reduce levels of moisture by drying clothes outside, covering pans when cooking, ensuring extraction fans are switched on in the bathroom and kitchen and shutting the bathroom door when showering

COMMON SYMPTOMS

of poor indoor air quality include:

- › coughing
- › sneezing
- › watery eyes
- › fatigue
- › dizziness
- › headaches
- › wheezing
- › allergic reactions



WHAT ARE INDOOR POLLUTANTS?

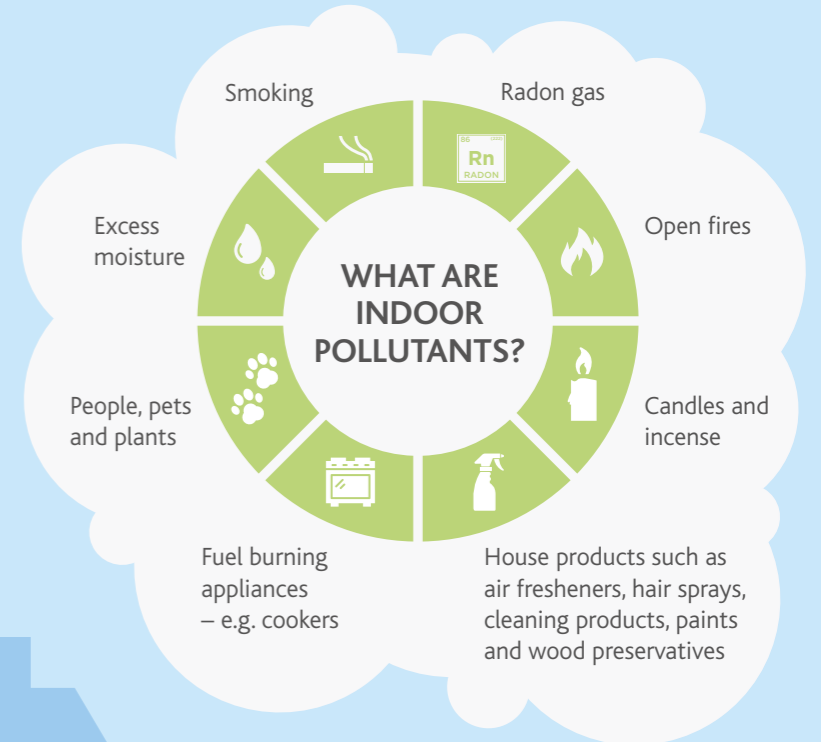

THE FACTS

On average, UK citizens spend **90%** of their time indoors...

That's **16 HOURS** a day in their homes

900 potentially dangerous chemicals, particles and biological materials in indoor air

The average family produces up to **10 litres** of water a day, leading to excess moisture that may result in condensation and mould growth

Your home could be **50x** more polluted than outdoors



NUAIRE

Western Industrial Estate

Caerphilly

CF83 1NA

Residential product orders or enquiries:

Tel: +44 (0)29 2085 8500

Fax: +44 (0)29 2085 8555

residential.enquiries@nuaire.co.uk

After sales technical support:

Tel: +44(0)29 2085 8400

Fax: +44(0)29 2085 8555

technicalsupport@nuaire.co.uk

www.nuaire.co.uk

11.19

8080 As part of our policy of continuous product development Nuaire reserves the right to alter specifications without prior notice.
Telephone calls may be recorded for quality and training purposes.